

Shadow II ULG+ Heater

Safety Instructions
and Operation Manual

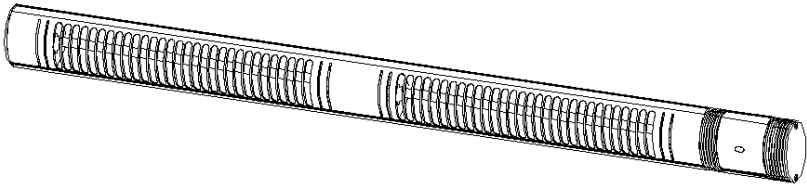

Model: 902672 -902673

(Note:This product is strictly prohibited to cover)

Thank you for purchasing our products.Please read carefully this instruction before

using and operate strictly accordance with the instructions, and especially pay attention to **"Important Safety Instructions"**. Please be careful collection after reading so as to for future reference.

Brief Introduction

This product is infrared radiant heater with remote control and IP 65 approved .It is almost unlimited used in outdoor ,such as open bars, courtyard, plaza, station, and construction site in winter etc. This patio heater is energy-efficient, convenient, environmentally friendly and for better life etc.

Important Safety Instructions

When using electrical appliances, basic safety precautions should always be followed to reduce the risk of fire, electric shock, or injury to persons, including the following:. Read all instructions before using this heater

- This heater is hot when in use .To avoid burns,do not let bare skin touch hot surfaces.If provided ,use handles when moving this heater.Keep combustible materials,such as furniture,pillows ,bedding ,papers,clothes and curtains at least 0.9m from the front of the heater.
- Extreme caution is necessary when any heater is used by or near children or invalids and whenever the heater is left operating and unattended.
- Always unplug heater when not in use
- Do not operate any heater with a damaged cord or plug or after the heater malfunctions, has been dropped or damaged in any manner. Discard heater, or return to authorized service facility for examination and/or repair.
- This heater is not intended for use in bathrooms, laundry areas and similar locations. Never locate heater where it may fall into a bathtub or other water container.
- Do not run cord under carpeting. Do not cover cord with throw rugs, runners, or similar coverings. Do not route cord under furniture or appliances. Arrange cord away from traffic area and where it will not be tripped over.
- Connect to properly grounded outlets only.
- To disconnect heater, turn controls off, then remove plug from outlet.
- Do not insert or allow foreign objects to enter any ventilation or exhaust opening as this may cause an electric shock or fire, or damage the heater.
- To prevent a possible fire, do not block air intakes or exhaust in any manner. Do not use on soft surfaces, like a bed, where openings may become blocked.
- A heater has hot and arcing or sparking parts inside. Do not use it in areas

where gasoline, paint, or flammable liquids are used or stored.

- Use this heater only as described in this manual. Any other use not recommended by the manufacturer may cause fire, electric shock, or injury to persons.
- Always plug heaters directly into a wall outlet/receptacle. Never use with an extension cord or relocatable power tap (outlet/power strip).
- Check if the voltage indicated on the nameplate of the appliance corresponds to the local mains voltage before you connect the appliance.
- The appliance is not located immediately below a wall socket-outlet.
- The casing and the front cover of the appliance become extremely hot during operation. Pay attention that, no combustible material due to wind or other environmental influences covers or obstructs the appliance, such as curtains, marquees, flags, plastic foil etc. Do not touch the appliance. Caution! Risk of scald injury!
- In case of improper use, there is a risk of electrical shock and/or fire hazard. Operation of the appliance must be discontinued and remove the mains plug immediately. Do not try to repair the appliance by your-self. Please contact with the service agent or a suitably qualified electrician for maintenance.
- Remove the plug from the power outlet and wait until the appliance is sufficiently cooled off before cleaning.
- Keep out of reach of children. In order to keep children from the dangers of electrical appliances, never leave them unsupervised with the machine. Consequently, when selecting the location for your machine, do so in such a way that children do not have access to the machine. Children being supervised not to play with the appliance.
- The appliance must only be mounted by an authorized specialist, paying attention to the relevant regulations of the power supply companies and the regional construction regulations.







Save These Instructions

SPECIFICATIONS

Specification	902672/902673
---------------	---------------

Voltage (V)	220-240V~
Power consumption (W)	1500Wx2
Production Dimensions(mm)	1178x135x83
IP code	IP65
Infrared receiving Angle	60°±5°

Remote Control Instructions

	Button	Graphic	Feature
	Up Arrow		Up one heating level
	Max		The heater goes directly to the highest heating level.
	Down Arrow		Down one heating level
	On		To switch the heater on: Press ON. The patio heater has a soft start function of 33% power. 4 seconds after the heater has been turned on, it will automatically switch to the last heating level used. In case of the first-time use, after 4seconds the heater will automatically switch to 100% power.
	Off		To switch the heater off: Press OFF. The heater will switch to standby mode(the receiver indicator will light up).

Notice:

- Use 2 pieces AAA size 1.5V batteries in the remote control. Remove the battery when not use for long time, thus the lifespan of remote control can be extended.
- Choose the same specification battery when replacing the battery inside, otherwise it may cause remote control not work, thereby affect the normal use of the heater.
- Please contact service agent for further help if you need the function.
- The remote control function may be out of work if there is a barrier between the remote control and heater.
- Replacing the batteries duly so as not to affect the normal use of heater and remote control.

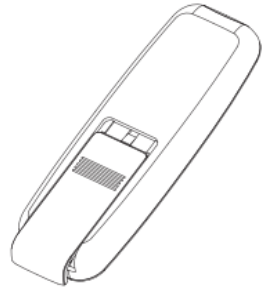

Operation Instruction

- Symbols for 3-way switch control indicate the following: 0. Off
(I). Remote function activated (II). Remote function override.
- Remove all package material (including anti-vibration object of the lamp) and check the appliance, supply cord and the plug for signs of damage.
- Pay attention to the mounting place and all mounting material (dowels, screws). Ensure they are suitable and stable enough for mounting and lastingly holding of the appliance.
- Before mounting, the minimum safe mounting distances and tilt angles shown in the figures must be strictly followed.
- The distance between the bottom edge of the appliance and the floor must be at least 1.8 M. See figure 2.
- There must be a distance of at least 0.25 M between the appliance and the ceilings, roofs or other covers. See figure 2.
- There must be a distance of at least 0.5 M at each side between the appliance and walls or the like. See figure 2.

- Recommended degree to mounting surface is 45°. See figure 3.
- Pay attention that, the installation of the appliance must not add excessive wind load.
- Fix the mounting bracket to the ceiling I first. Ensure that the place to be installed is secure and firm. Or connect the appliance to the stand.
- Adjust the desired angle of radiation and fest screw all screws. Check regularly the screw's connection. Mechanical bearing pressure and oscillation due to wind or rain could lead to loose.
- Plug in the power source and operate the remote control. Then observe, whether during the first 10-15 minutes the appliance works trouble-free.
- If you do not use, please remove battery socket

Figure1: Mounting bracket and anchor dowels provided. Connection from the wall to the infrared heater.

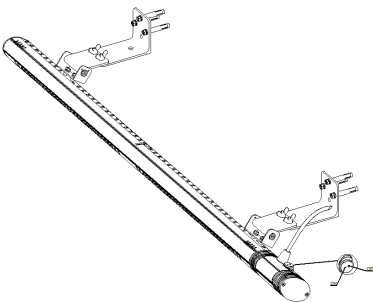

Figure2: Min. distance to floor, ceiling and wall.

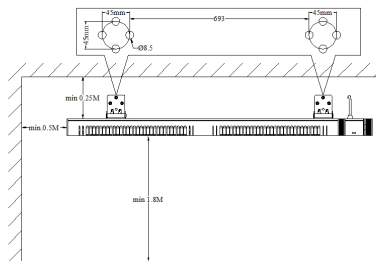
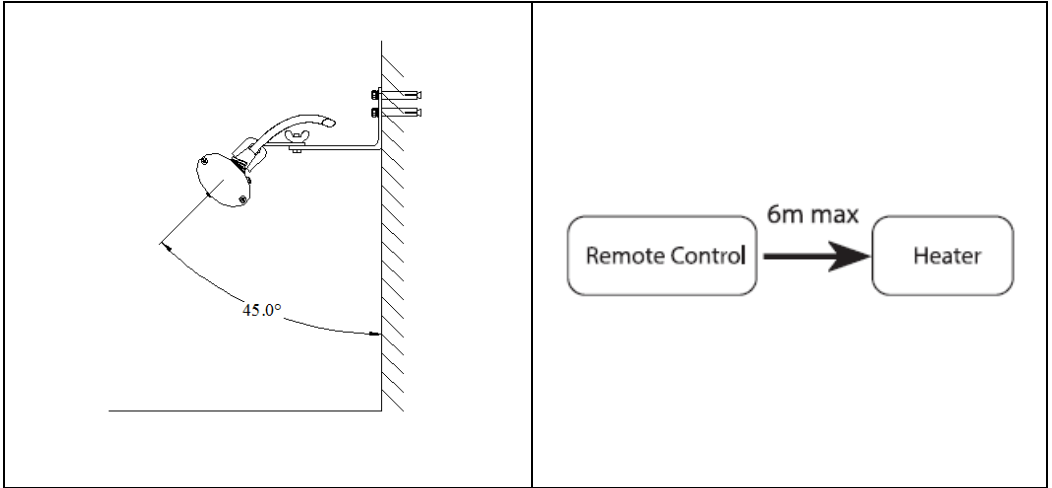

Figure3: Tilt angle.

Figure 4: Max.remote distance



Cleaning and Maintenance

- This appliance consists of a robust and maintenance-free aluminum casing with a protection cover. No user-serviceable parts inside.
- Before cleaning, remove the plug from the power outlet and wait until the appliance is sufficiently cooled off.
- Wipe the appliance only with clean and lint-free cloth or a soft brush.
- Never use abrasive cleaners, scrubbing brushes and chemical cleaners for cleaning!
- Can use alcohol to clean the appliance.
- To protect against electrical shock and danger of life, do not immerse cord, plug, or any part of the appliance in water or other liquid.
- For heating element replacement, please contact the manufacturer or its service agent or a similarly qualified person.
- Any other service, please contact with the service agent or a suitably qualified electrician.

Storage

Do not route cord when heater storage, or heater is not in use.

Disposal



- In accordance with European Directive 2011/65/EU concerning used electrical and electronic appliances (waste electrical and electronic equipment – WEEE), please return any electrical equipment that you will no longer use to the collection points provided for their disposal.
- This symbol indicates that the appliance cannot be treated as normal domestic trash, but must be handed to a collection point for recycling electric and electronic appliances.
- Information concerning where the equipment can be disposed of can be obtained from your local authority.

Customer Service

- Repairs must be carried out by authorized specialists, thus ensuring electrical safety.
- Please contact with the service agent or a suitably qualified electrician.
- Improper repairs could lead to danger to the user.
- This warranty does not cover damage of failure which results from alteration, accident, misuse, abuse, neglect, commercial use or improper maintenance.
- In line with our policy of continuous product development we reserve the right to change the product and documentation specifications without notice.